

SIDE ELEVATION

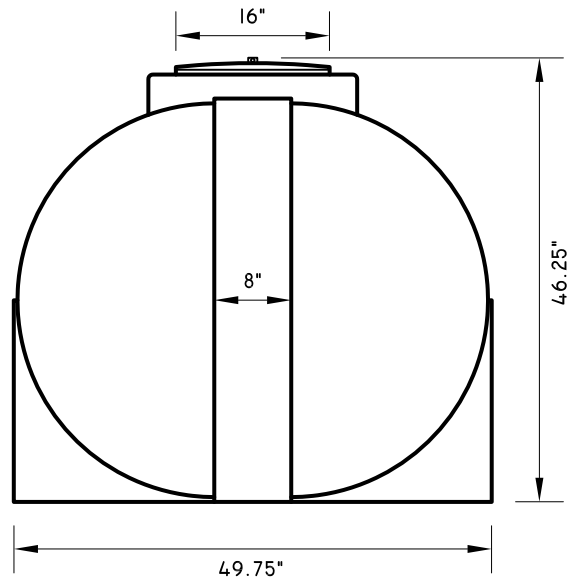

END ELEVATION

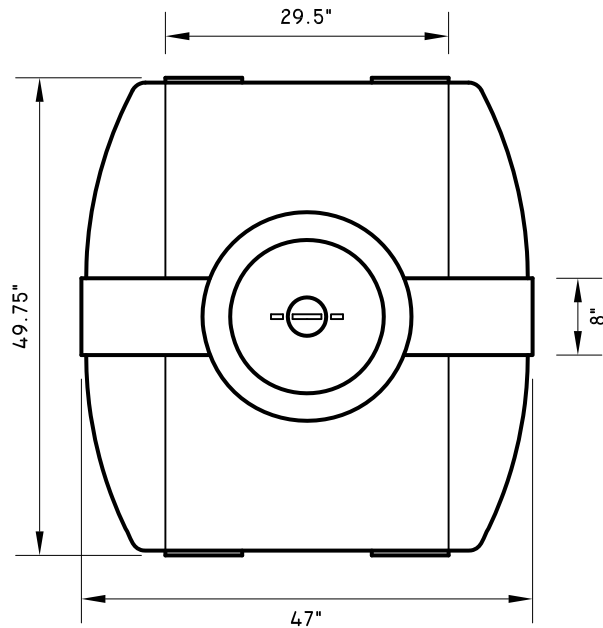

TOP VIEW



**PREMIER
PLASTICS INC.**
MANUFACTURERS OF ROTATIONALLY MOULDED PRODUCTS

8328 River Way
Delta, BC, Canada
V4G 1C4
www.premierplastics.com

Toll Free: 1-800-661-4473
Bus: (604) 952-6686
Fax: (604) 952-6696
E-mail: premier@ultranet.ca

HORIZONTAL LEG TANK

230 IMP. GALLON - LT230
275 US. GALLON - LTU275

POLYETHYLENE

DATE: DEC 2008

SCALE: NTS

DRAWN: SGM

DWG. No. LT230

REV.