

PLAN VIEW

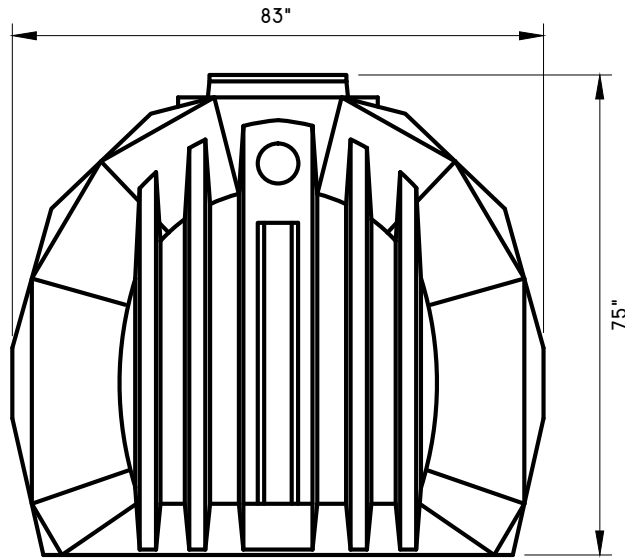

END VIEW

NOTE: ALL DIMENSIONS AND VOLUMES ARE NOMINAL



www.premierplastics.com 1-800-661-4473

PUMP OUT 'SUPERTANK'

CAN MODEL: PO1350 - 1350 IMP GAL

DATE: MAY 2011

SCALE: NTS

DRAWN: SGM

SHEET. No. 1 OF 2

REV. CAN

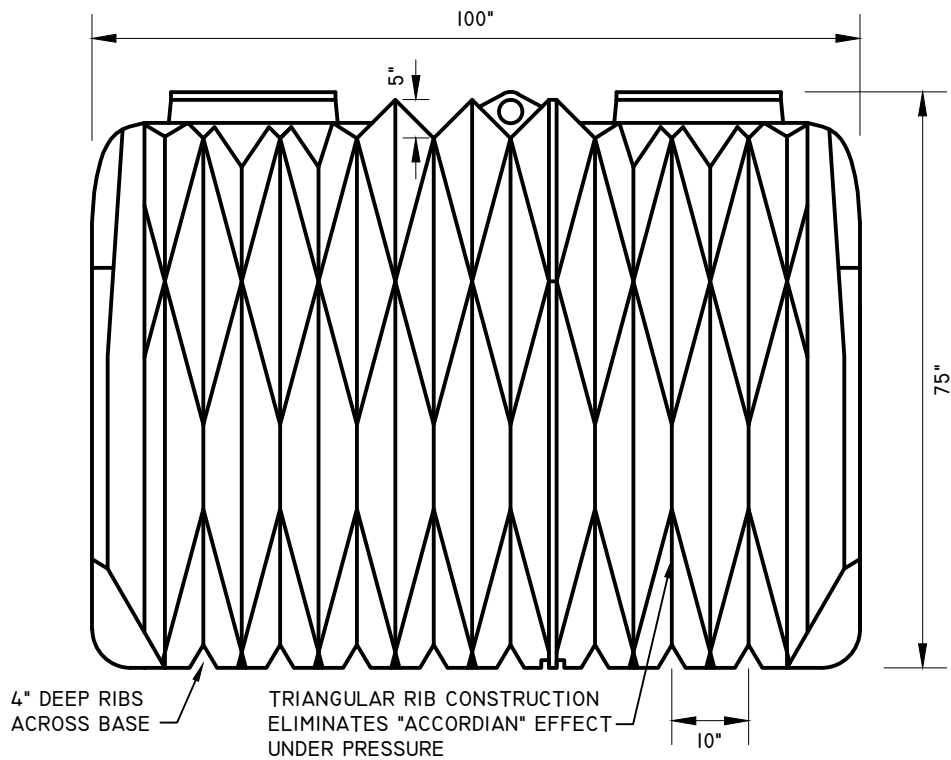

ELEVATION

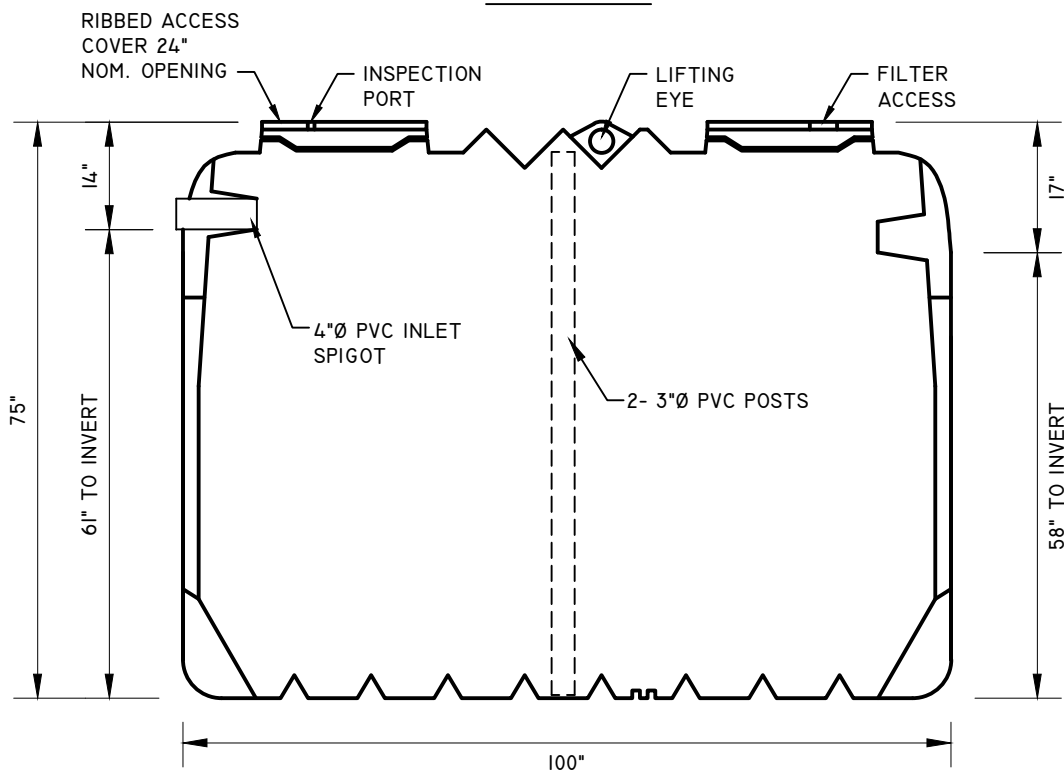

SECTION



www.premierplastics.com 1-800-661-4473

PUMP OUT 'SUPERTANK'

CAN. MODEL PO1350 - 1350 IMP GAL

DATE: JUNE 2010

SCALE: NTS

DRAWN: SGM

SHEET. No. 2 OF 2

REV. FEB 2019